

Mobile Crane Grue automotrice

LTM 1300-6.1

Technical Data Caractéristiques techniques

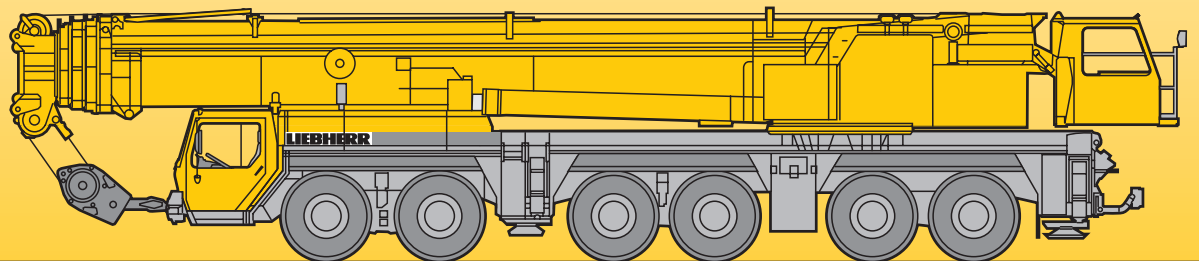

LIEBHERR

Lifting capacities on telescopic boom

Forces de levage à la flèche télescopique

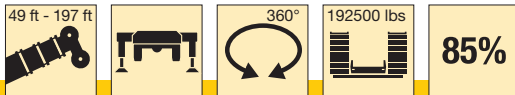





ft	49 ft		66 ft	83 ft	100 ft	117 ft	134 ft	151 ft	168 ft	185 ft	197 ft	ft
	*											
10	704	481										10
11	558	459										11
12	477	437	368									12
13	457	417	368									13
14	437	399	368	368								14
15	417	381	367	364								15
16	399	365	361	351								16
17	381	350	350	339	290							17
18	364	336	336	328	282							18
20	331	309	309	306	266	216						20
22	302	287	287	284	252	206						22
24	276	267	267	265	239	196	172					24
26	254	249	248	247	226	187	165					26
28	236	233	233	231	215	179	159	137				28
30	219	218	218	216	204	171	153	132	112			30
32	205	204	204	203	194	164	147	127	109			32
34	192	192	192	191	186	158	141	123	106	88.5		34
36	182	182	182	180	177	152	136	119	103	86.5		36
38	171	171	171	169	169	146	131	115	100	84.5		38
40			161	160	161	140	126	111	97.5	82.5	73.5	40
45			141	140	142	128	115	102	90.5	78	71	45
50			126	124	126	118	105	93.5	84	73.5	67	50
55			113	111	113	109	97	86.5	78	69.5	63.5	55
60				100	102	101	90	80	72.5	65	60.5	60
65				90.5	92.5	93.5	84	74	67.5	61.5	57.3	65
70				82.5	84.5	86.5	78.5	69.5	63	58.2	54.2	70
75					77	79.5	73.5	65	59.2	55	51.2	75
80					70.5	73	68.5	61	55.8	51.9	48.3	80
85					67	67	64.5	57.1	52.6	49.1	45.7	85
90					63.5	62	59.7	54.1	49.6	46.4	43.4	90
95						57.6	55.2	51.2	46.7	43.9	41.2	95
100						53.6	52.1	48.5	44.1	41.6	39.1	100
105							49.5	45.9	41.9	39.3	37.1	105
110							46.2	43.4	39.8	37.5	35.3	110
115							43.3	40.9	37.9	35.8	33.6	115
120							40.6	38.6	36	34.1	32.2	120
125								37.1	34.2	32.5	30.7	125
130								35.7	32.8	31	29.4	130
135								34.1	31.5	29.5	28.1	135
140								31.6	30	28.2	26.8	140
145									28.4	27.2	25.6	145
150									27.4	26.2	24.4	150
155									26.4	25.3	23.6	155
160										24.3	22.7	160
165										23.3	21.9	165
170										21.9	21	170
175										20.8	20.2	175
180											19.3	180
185											17.5	185
190											13.3	190

* over rear / en arrière

TAB 122363 / 122364

Lifting capacities on telescopic boom Forces de levage à la flèche télescopique

 49 ft - 197 ft

 360°
 247500 lbs
85%

ft	49 ft	66 ft	83 ft	100 ft	117 ft	134 ft	151 ft	168 ft	185 ft	197 ft	ft
14			368								14
15	389	368	364								15
16	373	367	351								16
17	359	359	339	290							17
18	346	345	328	282							18
20	320	320	306	266	216						20
22	297	297	288	252	206						22
24	277	277	270	239	196	172					24
26	258	258	254	226	187	165					26
28	243	243	240	215	179	159	137				28
30	228	228	226	204	171	153	132	112			30
32	216	215	213	194	164	147	127	109			32
34	204	204	202	186	158	141	123	106	88.5		34
36	194	194	192	177	152	136	119	103	86.5		36
38	184	183	181	169	146	131	115	100	84.5		38
40		174	172	161	140	126	111	97.5	82.5	73.5	40
45		153	152	146	128	115	102	90.5	78	71	45
50		137	135	133	118	105	93.5	84	73.5	67	50
55		123	121	121	109	97	86.5	78	69.5	63.5	55
60			109	111	101	90	80	72.5	65	60.5	60
65			99	101	93.5	84	74	67.5	61.5	57.3	65
70			91	92.5	87.5	78.5	69.5	63	58.2	54.2	70
75				85	82	73.5	65	59.2	55	51.2	75
80				78.5	77	68.5	61	55.8	51.9	48.3	80
85				73	72	64.5	57.1	52.6	49.1	45.7	85
90				68	68.5	60.5	54.1	49.6	46.4	43.4	90
95					64.5	56.9	51.2	46.7	43.9	41.2	95
100					61	53.5	48.5	44.1	41.6	39.1	100
105						50.8	45.9	41.9	39.3	37.1	105
110						48.2	43.4	39.8	37.5	35.3	110
115						45.8	41.3	37.9	35.8	33.6	115
120						43.8	39.3	36	34.1	32.2	120
125							37.4	34.2	32.5	30.7	125
130							35.7	32.8	31	29.4	130
135							34.3	31.5	29.5	28.1	135
140							31.9	30.1	28.2	26.8	140
145								28.7	27.2	25.6	145
150								27.4	26.2	24.4	150
155								26.4	25.3	23.6	155
160									24.3	22.7	160
165									23.4	21.9	165
170									22.4	21	170
175									21.4	20.2	175
180										19.4	180
185										17.6	185
190										13.3	190

TAB 122362

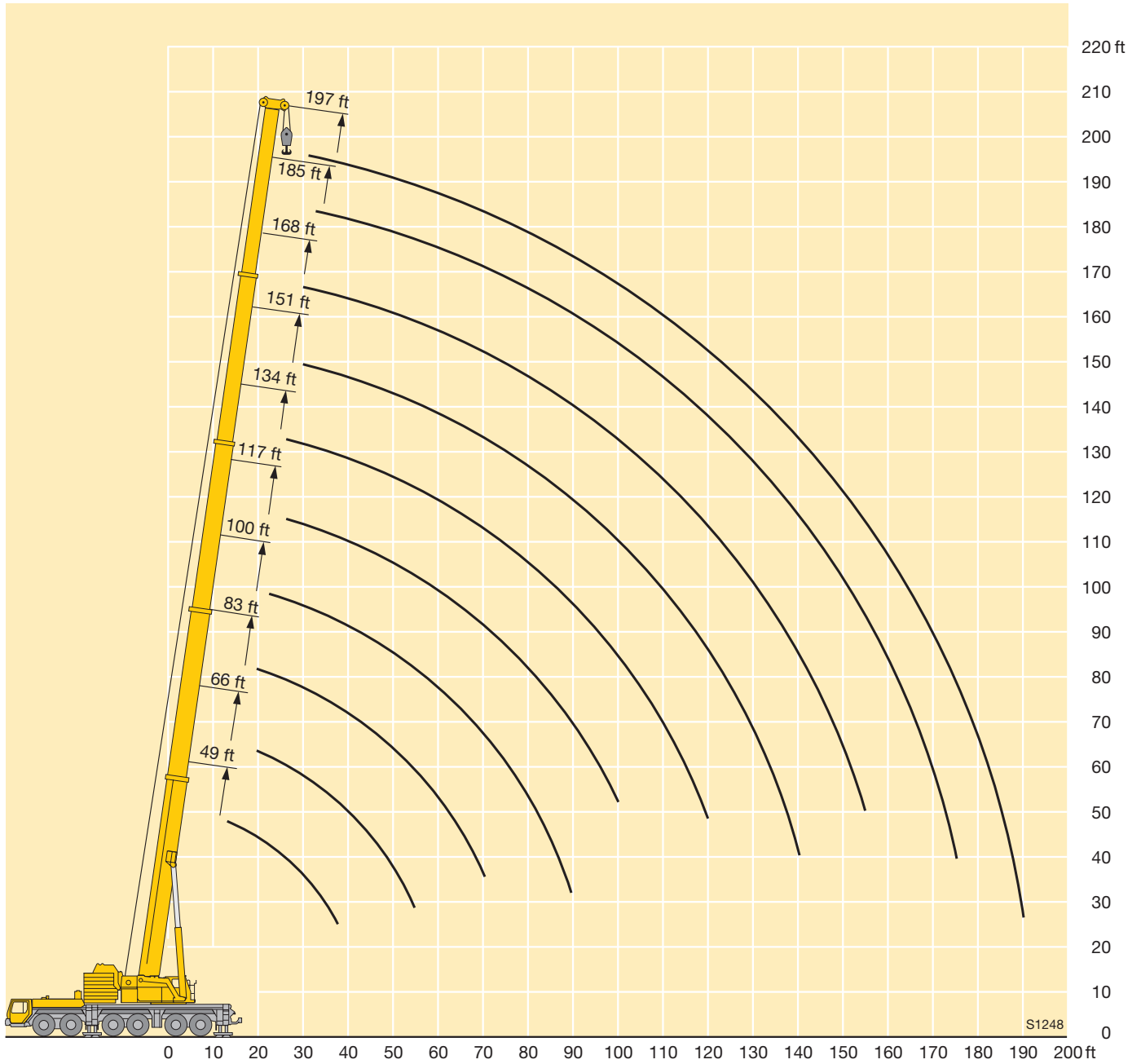
Lifting heights Hauteurs de levage



Lifting capacities on gayed telescopic boom Forces de levage à la flèche télescopique haubanée

	100 - 197 ft					85%						
	ft	100 ft	117 ft	134 ft	151 ft	168 ft	185 ft	197 ft	ft			
24		267	223	183					24			
26		254	219	180					26			
28		241	216	178	143				28			
30		228	212	175	142	115			30			
32		215	208	173	140	114			32			
34		204	201	171	138	113	92.5		34			
36		193	191	168	137	111	92		36			
38		183	181	165	135	110	91		38			
40		173	172	162	133	109	90.5	75	40			
45		153	155	154	129	106	88.5	75	45			
50		137	140	140	125	104	86.5	74.5	50			
55		122	125	126	119	101	84.5	73.5	55			
60		110	113	114	114	98	83	72.5	60			
65		99.5	102	103	104	95	81	71	65			
70		90.5	93.5	94.5	95.5	92	79	69.5	70			
75		83	86	86.5	88	86.5	77	68	75			
80		76	79	79.5	81	81	75.5	66.5	80			
85		69.5	72.5	73	74.5	76.5	73.5	65	85			
90		64	67	67.5	69	71	69	63.5	90			
95			62	62.5	64	66	64.5	62.5	95			
100			57.5	58	59.4	61.5	59.9	59.9	100			
105				53.9	55.3	57.3	55.7	55.8	105			
110				50.2	51.6	53.7	52.1	52.1	110			
115				46.8	48.2	50.3	48.7	48.8	115			
120				43.7	45.1	47.1	45.5	45.6	120			
125					42.2	44.2	42.6	42.7	125			
130					39.5	41.6	40	40.1	130			
135					37.1	39.1	37.5	37.6	135			
140					31.9	36.8	35.2	35.4	140			
145						34.6	33.1	33.2	145			
150						32.6	31.1	31.2	150			
155						30.8	29.2	29.3	155			
160							27.4	27.5	160			
165							25.7	25.8	165			
170							24.1	24.2	170			
175								22.8	175			
180								21.4	180			

TAB 122365

Remarks referring to load charts

1. The tabulated lifting capacities do not exceed 85 % of the tipping load. The crane's structural steelworks is in accordance with DIN 15018, part 3. Design and construction of the crane comply with DIN 15018, part 2, and with F. E. M. regulations.
2. The 85 % overturning limit values take into account wind force 5 = wind speed 20 mph.
3. Lifting capacities are given in kips.
4. The weight of the hook blocks and hooks must be deducted from the lifting capacities.
5. Working radii are measured from the slewing centreline.
6. The lifting capacities given for the telescopic boom only apply if the folding jib is taken off.
7. Lifting capacities are subject to modifications.
8. Lifting capacities above 352 kips only with additional pulley block.
9. Lifting capacities above 522 kips only with special equipments.

Remarques relatives aux tableaux des charges

1. Les forces de levage indiquées ne dépassent pas 85 % de la charge de basculement. La norme DIN 15018, 3ème partie est appliquée pour les charpentes. La construction de la grue est réalisée conformément à la norme DIN 15018, 2ème partie, et aux règles de la F. E. M.
2. A 85 % de la charge de basculement, il a été tenu compte d'un vent de force 5 = vitesse de vent 20 mph.
3. Les forces de levage sont données en kips.
4. Les poids des moules et crochets doit être soustrait des charges indiquées.
5. Les portées sont calculées à partir de l'axe de rotation.
6. Les forces indiquées pour la flèche télescopique s'entendent fléchette dépliée déposée.
7. Les forces de levage sont modifiables sans préavis.
8. Les charges supérieures à 352 kips ne peuvent être levées qu'avec un moufle complémentaire.
9. Forces de levage plus de 522 kips seulement avec équipements supplémentaires.

Lifting capacities on guyed telescopic boom

Forces de levage à la flèche télescopique haubanée







ft	100 ft	117 ft	134 ft	151 ft	168 ft	185 ft	197 ft	ft
17	303							17
18	300							18
20	292	232						20
22	280	227						22
24	266	223	183					24
26	250	219	180					26
28	234	216	178	143				28
30	219	211	175	142	115			30
32	206	203	173	140	114			32
34	195	193	171	138	113	92.5		34
36	184	183	168	137	111	92		36
38	173	172	165	135	110	91		38
40	163	166	161	133	109	90.5	75	40
45	142	145	145	129	106	88.5	75	45
50	126	129	130	124	104	86.5	74.5	50
55	112	115	116	116	101	84.5	73.5	55
60	101	104	104	106	97.5	83	72.5	60
65	91	94	94.5	96	93.5	81	71	65
70	82	85.5	86	87.5	87.5	79	69.5	70
75	74.5	77.5	78.5	79.5	82	76.5	68	75
80	67.5	71	71.5	72.5	75	73	66.5	80
85	61.5	64.5	65	66.5	69	67	65	85
90	56.2	59.4	59.9	61.5	63.5	62	61.5	90
95		57.1	55.2	56.6	58.8	57.1	57.1	95
100		55.2	50.9	52.3	54.4	52.7	52.8	100
105			46.9	48.3	50.5	48.8	48.9	105
110			43.5	44.9	47	45.3	45.4	110
115			40.3	41.7	43.8	42.2	42.2	115
120			37.4	40.5	40.9	39.2	39.3	120
125				38.7	38.1	36.5	36.5	125
130				36.2	35.6	34	34.1	130
135				33.9	33.3	31.7	31.8	135
140				30.7	31.2	29.6	29.6	140
145					29.2	27.6	27.7	145
150					27.3	25.7	25.8	150
155					25.6	24	24.1	155
160						22.4	22.5	160
165						20.8	20.9	165
170						19.4	19.5	170
175							18.1	175
180							16.8	180

TAB 122353

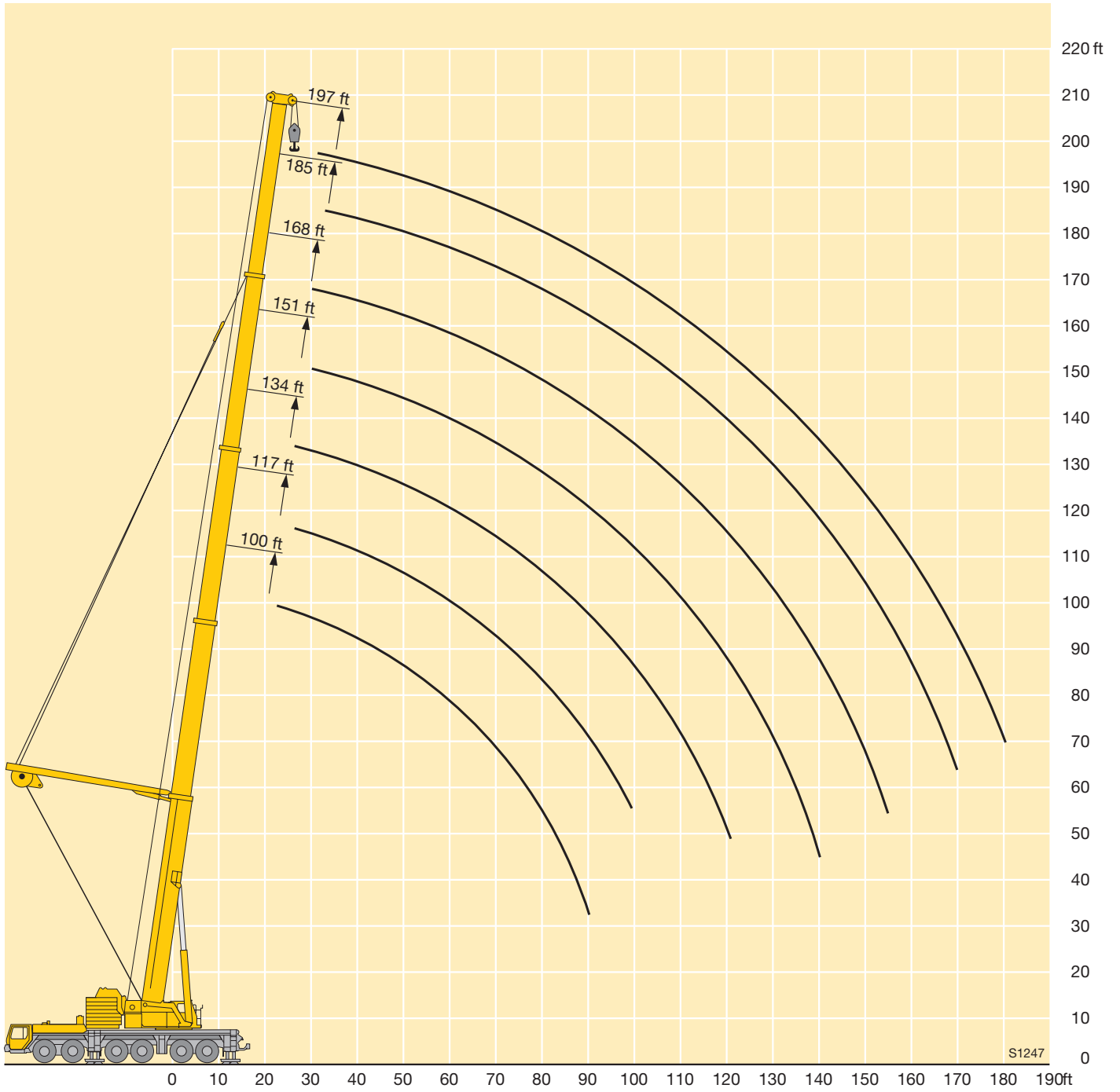
Lifting heights Hauteurs de levage



Lifting capacities on the lattice fly jib

Forces de levage à la fléchette treillis fixe

ft	151 ft + 8 ft*		168 ft + 8 ft*		185 ft + 8 ft*			197 ft + 8 ft*		ft
	46 ft	46 ft	46 ft	69 ft	92 ft	115 ft	138 ft	138 ft		
40	61.5								40	
45	58.9								45	
50	56.1	49.3	38.1						50	
55	53.4	47.2	36.5	28.2					55	
60	50.8	45	35	27	21.6				60	
65	48.3	43.1	33.6	25.9	20.7				65	
70	46	41	32	24.9	19.9	15.6			70	
75	43.8	39	30.6	23.8	19	14.9	11.4		75	
80	41.7	37.1	29.2	22.7	18	14.1	10.7	9.6	80	
85	40	35.3	27.9	21.6	17.2	13.3	10.1	9.4	85	
90	38.3	33.6	26.8	20.6	16.3	12.6	9.5	8.9	90	
95	36.8	32.2	25.6	19.6	15.6	11.9	8.9	8.4	95	
100	35.2	30.8	24.6	18.8	14.8	11.3	8.4	8	100	
105	33.5	29.4	23.5	18	14.1	10.7	8	7.7	105	
110	31.5	28	22.6	17.2	13.5	10.1	7.7	7.3	110	
115	29.9	26.7	21.6	16.5	12.8	9.6	7.3	7	115	
120	28.4	25.4	20.8	15.8	12.2	9.1	7	6.7	120	
125	26.9	24.1	19.9	15.2	11.7	8.6	6.7	6.4	125	
130	25.6	22.9	19.1	14.5	11.2	8.3	6.3	6.1	130	
135	24.3	21.7	18.4	14	10.7	7.9	6.1	5.9	135	
140	23	20.6	17.7	13.4	10.2	7.6	5.8	5.6	140	
145	21.7	19.5	17	12.9	9.8	7.3	5.5	5.4	145	
150	20.5	18.4	16.4	12.5	9.3	7	5.3	5.1	150	
155	19.6	17.4	15.7	12	9	6.7	5	4.9	155	
160	18.7	16.4	14.9	11.5	8.7	6.5	4.8	4.7	160	
165	17.8	15.5	14.1	11.1	8.4	6.2			165	
170	17	14.7	13.3	10.6	8.1	6			170	
175	16.2	14	12.5	10.2	7.9	5.8			175	
180	15.2	13.3	11.8	9.9	7.6	5.5			180	
185	14	12.6	11.1	9.6	7.3	5.3			185	
190	12.9	11.9	10.4	9.2	7.1	5.1			190	
195		11.3	9.8	8.8	6.9	4.9			195	
200		10.5	9.3	8.3	6.7	4.7			200	
205			8.9	7.8	6.5	4.5			205	
210			8.5	7.3	6.3	4.4			210	
215			8.1	6.9	6.1	4.2			215	
220			7.7	6.6	5.9	4.1			220	
225				6.3	5.7	4			225	
230				6	5.3	3.8			230	
235				5.6	5.1	3.7			235	
240				5.3	4.8	3.5			240	
245					4.5	3.4			245	
250					4.2	3.3			250	
255					3.9	3			255	
260					3.7	2.8			260	
265					3.4				265	

* adapter / pièce d'adaptateur

Lifting capacities on the lattice fly jib

Forces de levage à la fléchette treillis fixe



ft	151 ft + 8 ft*		168 ft + 8 ft*		185 ft + 8 ft*								ft
	46 ft		46 ft		46 ft		69 ft		92 ft		115 ft		
	20°	40°	20°	40°	20°	40°	20°	40°	20°	40°	20°	40°	
60	41.5		39.9										60
65	39.8		38.3										65
70	38.2	26.8	36.6		26.8								70
75	36.7	26.3	35	26	25.7								75
80	35.3	25.8	33.4	25.5	24.7	22	18.5						80
85	34	25.3	32	25.1	23.7	21.3	17.7						85
90	32.8	24.9	30.6	24.7	22.8	20.7	17						90
95	31.8	24.4	29.4	24.4	22	20	16.3		12.4				95
100	30.7	24.1	28.3	24	21.3	19.4	15.7	13.8	11.9				100
105	29.8	23.8	27.2	23.7	20.6	18.9	15.1	13.4	11.4		8.3		105
110	28.9	23.6	26.2	23.4	19.9	18.3	14.5	13	10.9		8		110
115	28	23.3	25.2	23.2	19.2	17.8	14	12.6	10.4	8.6	7.7		115
120	27.1	23.1	24.2	23	18.6	17.4	13.5	12.2	10	8.5	7.4		120
125	26.5	22.8	23.3	22.7	18	16.9	13	11.8	9.7	8.4	7.1		125
130	25.8	22.6	22.6	22	17.5	16.5	12.6	11.4	9.3	8.2	6.9		130
135	24.7	22.6	21.8	21.3	17	16.1	12.1	11.1	9	8	6.6	5.2	135
140	23.5	22.6	20.9	20.7	16.5	15.8	11.7	10.8	8.6	7.8	6.4	5.1	140
145	22.3	22.5	20	20.1	16	15.4	11.4	10.5	8.3	7.6	6.1	5	145
150	21.1	21.6	18.9	19.4	15.5	15.1	11	10.2	8.1	7.4	5.9	4.9	150
155	20.1	20.5	17.9	18.4	14.9	14.7	10.6	10	7.8	7.3	5.7	4.8	155
160	19.2	19.5	16.9	17.4	14.5	14.3	10.3	9.7	7.6	7.1	5.5	4.7	160
165	18.3	18.5	15.9	16.5	14	13.9	10	9.5	7.4	6.9	5.3	4.6	165
170	17.4	17.6	15.1	15.6	13.6	13.6	9.7	9.3	7.2	6.7	5.1	4.6	170
175	16.6	16.7	14.4	14.7	13	13.2	9.5	9.1	7	6.6	4.9	4.5	175
180	15.7		13.6	13.9	12.3	12.8	9.3	8.9	6.8	6.4	4.8	4.4	180
185	14.6		12.9	13.1	11.5	12.1	9.1	8.7	6.6	6.3	4.6	4.2	185
190	13.4		12.1	12.3	10.8	11.4	8.8	8.7	6.4	6.2	4.4	4.1	190
195			11.4		10.3	10.7	8.6	8.5	6.3	6	4.3	4	195
200			10.7		9.8	10	8.3	8.4	6.1	5.9	4.1	3.9	200
205					9.2		8.1	8.3	6	5.8	4	3.8	205
210					8.7		7.9	8.1	5.8	5.7	3.9	3.7	210
215					8.2		7.5	7.8	5.7	5.7	3.7	3.6	215
220					7.8		7.1	7.3	5.5	5.6	3.6	3.5	220
225							6.7	6.9	5.4	5.5	3.5	3.4	225
230							6.3		5.4	5.4	3.4	3.3	230
235							6		5.3	5.4	3.3	3.3	235
240							5.6		5.1	5.3	3.2	3.2	240
245									4.9	5.1	3.1	3.1	245
250									4.5		3	3.1	250
255									4.2		3	3	255
260									3.9		2.9	3	260
265									3.6		2.9	3	265

* adapter / pièce d'adaptateur

TAB 122373 / 122374

Lifting heights Hauteurs de levage

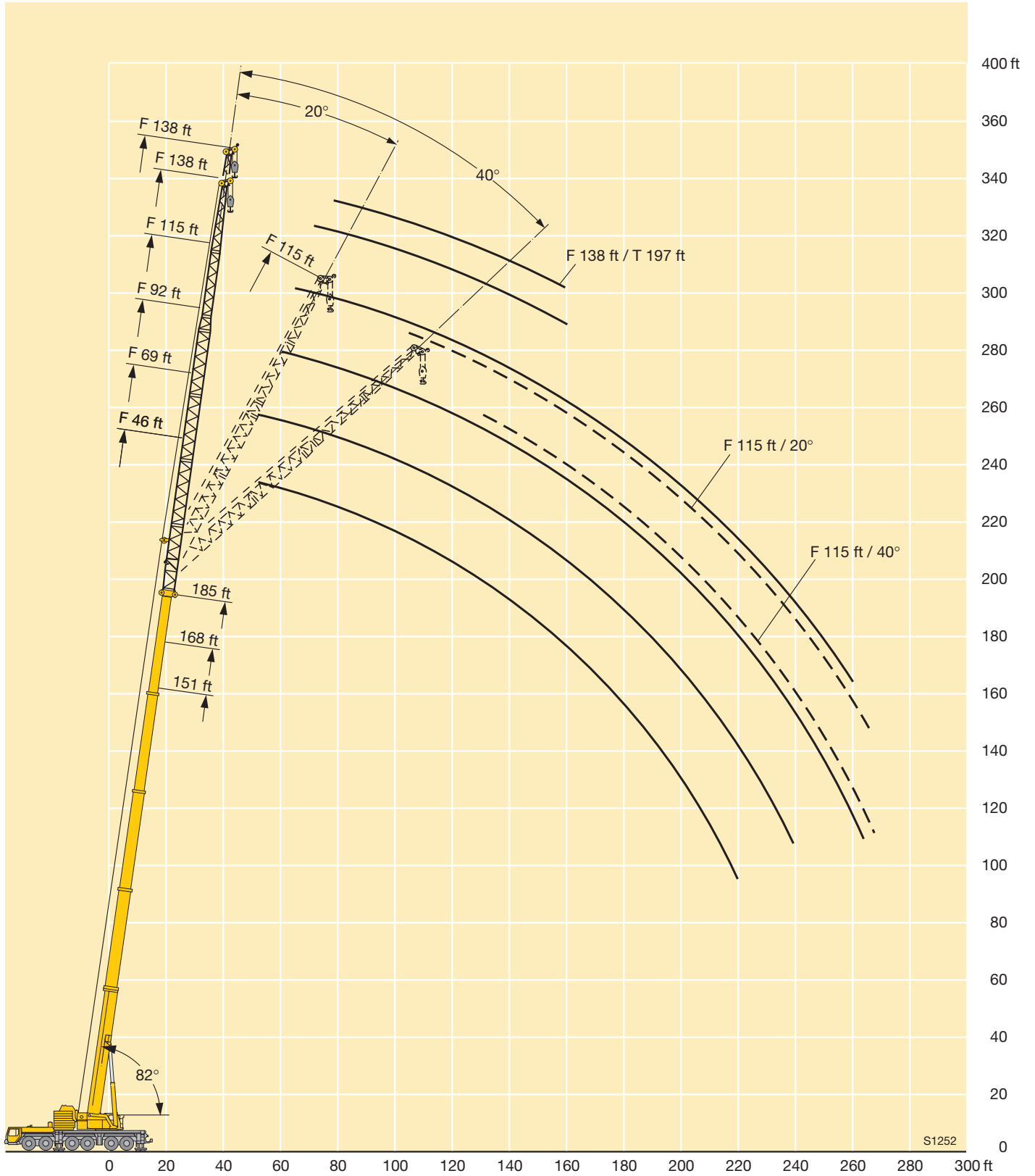

Lifting capacities on the lattice fly jib with guyed telescopic boom

Forces de levage à la fléchette treillis fixe avec flèche télescopique haubanée



ft	151 ft + 8 ft*		168 ft + 8 ft*		185 ft + 8 ft*						197 ft + 8 ft*		ft
	46 ft	46 ft	46 ft	69 ft	92 ft	115 ft	138 ft	161 ft	138 ft	161 ft			
40	68											40	
45	68											45	
50	66.5	54.6	40.9									50	
55	64.5	54	40.5	32.6								55	
60	62	53.2	39.9	32.2	24.9							60	
65	59.9	52.3	39.2	31.6	24.8							65	
70	58	51.5	38.6	30.8	24.4	19.6						70	
75	56.1	50.5	38	30	24	19.2	14.6					75	
80	54.3	49.5	37.4	29.3	23.4	18.7	14.5	9.7	12.1			80	
85	52.5	48.6	36.7	28.6	22.7	18.1	14.1	9.7	12.1			85	
90	50.8	47.5	35.9	27.8	22.1	17.5	13.7	9.6	12	8		90	
95	49.2	46.5	35.1	27	21.6	17	13.2	9.3	11.7	8		95	
100	47.6	45.5	34.2	26.2	21.1	16.5	12.7	9	11.3	7.9		100	
105	46.2	44.6	33.5	25.5	20.6	16	12.2	8.7	10.9	7.7		105	
110	44.8	43.6	32.7	24.9	20	15.5	11.8	8.4	10.6	7.4		110	
115	43.6	42.6	32	24.2	19.4	15.1	11.3	8.1	10.2	7.2		115	
120	41.7	41.2	31.3	23.6	18.9	14.6	10.9	7.8	9.9	6.9		120	
125	38.8	38.9	30.6	23	18.4	14.1	10.5	7.6	9.5	6.7		125	
130	36.2	36.3	30	22.4	17.9	13.7	10.1	7.3	9.2	6.5		130	
135	33.7	33.8	29.3	21.8	17.4	13.3	9.8	7.1	8.9	6.3		135	
140	31.4	31.5	28.7	21.3	17	12.9	9.5	6.8	8.6	6		140	
145	29.3	29.4	28.1	20.8	16.5	12.5	9.1	6.5	8.3	5.8		145	
150	27.3	27.4	27.6	20.3	16.1	12.1	8.8	6.3	8	5.6		150	
155	25.4	25.5	26.2	19.8	15.7	11.7	8.6	6	7.8	5.4		155	
160	23.6	23.7	24.6	19.3	15.3	11.3	8.3	5.8	7.5	5.2		160	
165	22	22.1	22.9	18.9	15	10.9	8	5.6	7.3	5		165	
170	20.3	20.5	21.3	18.4	14.6	10.6	7.8	5.3	7.1	4.8		170	
175	18.8	18.9	19.8	18	14.2	10.3	7.5	5.1	6.9	4.6		175	
180	17.4	17.5	18.4	17.6	13.9	10.1	7.3	4.9	6.7	4.4		180	
185	16	16.1	17	17.1	13.6	9.8	7.1	4.8	6.5	4.2		185	
190	14.7	14.8	15.6	16.1	13.3	9.6	6.9	4.6	6.3	4.1		190	
195		13.6	14.4	14.9	13	9.4	6.7	4.4	6.1			195	
200		12.4	13.2	13.7	12.8	9.1	6.6	4.2	5.9			200	
205			12	12.5	12.6	8.9	6.4	4.1	5.8			205	
210			10.9	11.4	12.3	8.7	6.2	3.9	5.6			210	
215			9.9	10.3	11.2	8.5	6	3.8	5.5			215	
220			9.2	9.5	10.2	8.3	5.9	3.6	5.3			220	
225				8.8	9.4	8.1	5.7	3.5	5.2			225	
230				8.2	8.7	7.9	5.5	3.3	5			230	
235				7.5	8.1	7.8	5.4	3.2	4.9			235	
240				6.9	7.5	7.4	5.3		4.8			240	
245					6.9	6.9	5.2		4.6			245	
250					6.4	6.4	5.1		4.5			250	
255					5.8	5.9	4.9		4.3			255	
260					5.3	5.3	4.8		4.2			260	
265					4.8	4.8	4.7		4			265	
270					4.4	4.4	4.5		3.8			270	
275					3.9	3.9	4		3.5			275	
280					3.5	3.5	3.6		3.1			280	
285					3.1	3.1	3.2					285	
290							2.7					290	
295							2.4					295	

* adapter / pièce d'adaptateur

TAB 122375

Lifting capacities on the lattice fly jib with guyed telescopic boom

Forces de levage à la flèche treillis fixe avec flèche télescopique haubanée



ft	151 ft + 8 ft*		168 ft + 8 ft*		185 ft + 8 ft*										ft
	46 ft		46 ft		46 ft		69 ft		92 ft		115 ft		138 ft		
	20°	40°	20°	40°	20°	40°	20°	40°	20°	40°	20°	40°	20°		
60	46.5		45.1												60
65	45.2		44												65
70	44	27.5	42.9		35.5										70
75	42.7	26.9	42	26.8	34.5										75
80	41.4	26.4	41	26.3	33.6	26.1	24.2								80
85	40.2	25.9	40.1	25.9	32.8	25.6	23.5								85
90	39.2	25.4	39.1	25.5	32	25.2	22.8								90
95	38.2	25	38.2	25	31.2	24.8	22.2			17.1					95
100	37.3	24.6	37.4	24.6	30.5	24.5	21.6	15.1	16.6						100
105	36.4	24.3	36.6	24.3	29.8	24.1	21	14.8	16.2						105
110	35.5	23.9	35.8	24	29.1	23.8	20.4	14.6	15.8						110
115	34.7	23.7	35	23.7	28.5	23.6	19.9	14.3	15.5	9	10.8				115
120	34	23.4	34.3	23.5	27.9	23.3	19.4	14.1	15.1	8.8	10.5				120
125	33.4	23.1	33.6	23.2	27.3	23	19	13.9	14.8	8.7	10.2			7	125
130	32.7	22.8	33.1	23	26.8	22.8	18.5	13.7	14.4	8.5	9.9			6.8	130
135	32.2	22.7	32.6	22.7	26.3	22.6	18.1	13.5	14.1	8.4	9.7	5.3		6.6	135
140	31.6	22.6	32	22.6	25.8	22.5	17.7	13.3	13.7	8.3	9.4	5.2		6.4	140
145	30.9	22.5	31.2	22.5	25.4	22.3	17.4	13.1	13.4	8.2	9.1	5.1		6.3	145
150	28.9	22.5	29.1	22.5	25	22.2	17	13	13.1	8.1	8.8	5		6.1	150
155	26.9	22.4	27.1	22.4	24.5	22.1	16.7	12.9	12.8	7.9	8.6	4.9		5.9	155
160	25	22.3	25.3	22.4	24.2	22	16.3	12.8	12.5	7.8	8.4	4.9		5.8	160
165	23.2	22.2	23.5	22.3	23.8	21.9	16	12.7	12.2	7.7	8.2	4.8		5.6	165
170	21.5	21.8	21.8	22.3	22.7	21.9	15.8	12.6	11.9	7.6	8	4.7		5.4	170
175	19.9	20.1	20.2	20.8	21.2	21.4	15.6	12.5	11.7	7.6	7.8	4.6		5.3	175
180	18.3		18.6	19.2	19.6	20.3	15.3	12.4	11.4	7.5	7.7	4.6		5.2	180
185	16.8		17.2	17.6	18.2	18.8	15.1	12.4	11.2	7.5	7.5	4.5		5	185
190	15.3		15.8	16	16.8	17.3	14.9	12.4	11	7.4	7.3	4.4		4.9	190
195			14.4		15.4	15.9	14.7	12.4	10.8	7.4	7.2	4.4		4.7	195
200			13.1		14.2	14.5	14.5	12.4	10.7	7.3	7.1	4.4		4.6	200
205					12.9		14	12.4	10.5	7.3	6.9	4.3		4.5	205
210					11.7		12.9	12.4	10.4	7.3	6.8	4.3		4.4	210
215					10.5		11.8	12.1	10.2	7.3	6.7	4.3		4.3	215
220					9.5		10.6	11.2	10.1	7.3	6.6	4.2		4.2	220
225							9.7	10	9.9	7.3	6.5	4.2		4.1	225
230							8.9		9.7	7.3	6.4	4.2		4	230
235							8.2		9.3	7.3	6.3	4.2		3.9	235
240							7.5		8.6	7.3	6.2	4.2		3.8	240
245									7.9	7.3	6.1	4.2		3.8	245
250									7.3		6	4.2		3.7	250
255									6.6		5.9	4.2		3.6	255
260									6		5.8	4.2		3.5	260
265									5.4		5.7	4.2		3.5	265
270											5.4	4.2		3.4	270
275											4.9	4.2		3.3	275
280											4.3			3.2	280
285											3.7			3.1	285
290														3	290
295														2.9	295
300														2.8	300

* adapter / pièce d'adaptateur

TAB 122376 / 122377

Lifting heights Hauteurs de levage

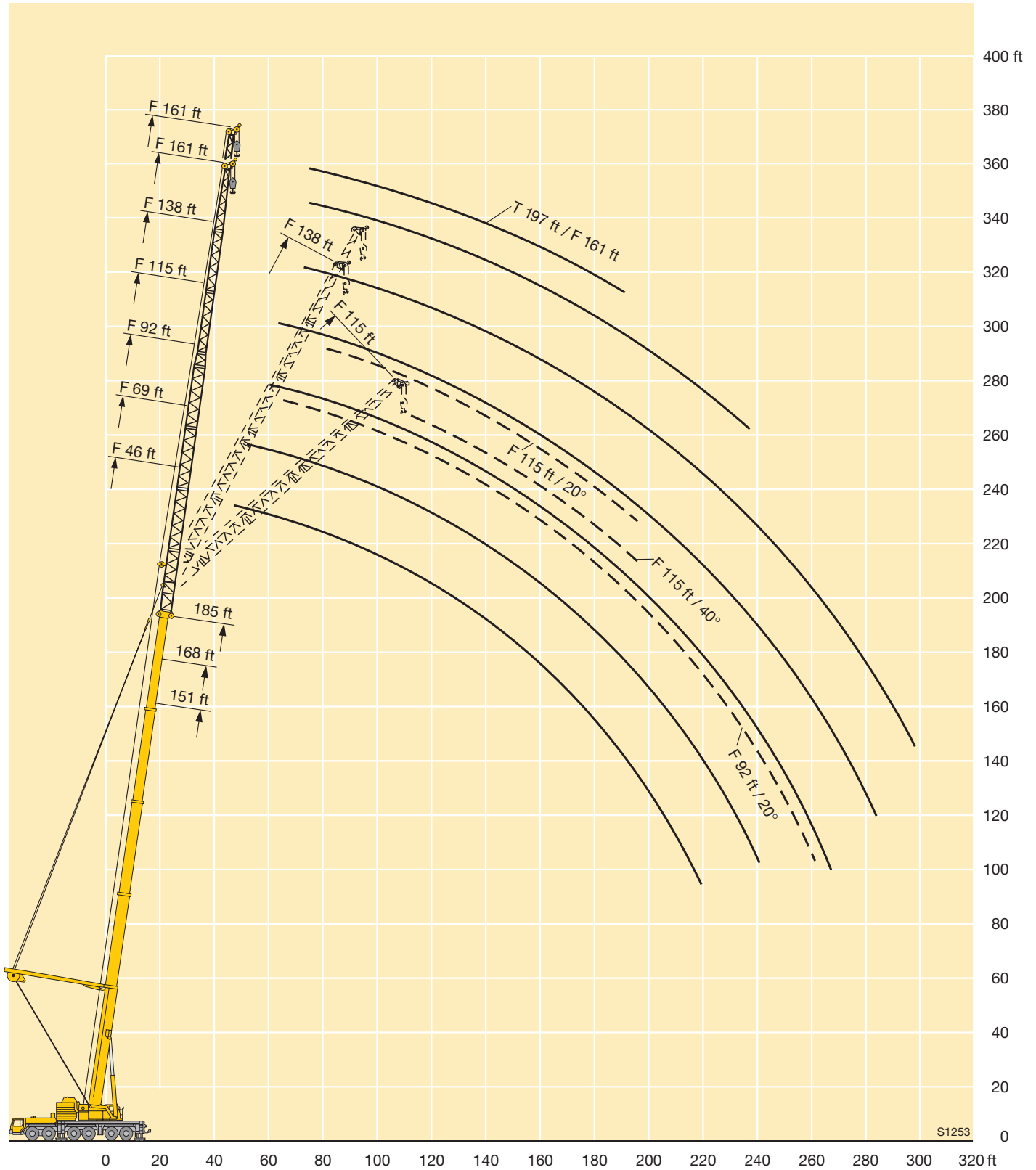

Lifting capacities on the luffing lattice jib

Forces de levage à la fléchette treillis relevable



ft	49 ft + 13 ft*									83 ft + 13 ft*						ft	
	57 ft	69 ft	92 ft	115 ft	138 ft	161 ft	184 ft	207 ft	230 ft	57 ft	69 ft	92 ft	115 ft	138 ft	161 ft		
30	170															30	
32	165															32	
34	160	150								133						34	
36	156	146								133						36	
38	152	142								133						38	
40	148	139	118							133	112					40	
45	140	131	114							133	111					45	
50	135	125	110	90.5						131	111	88.5				50	
55	124	119	106	88.5	71.5					125	111	87.5	68			55	
60		114	102	86.5	70.5					115	110	86.5	68	53.3		60	
65		108	98.5	84.5	69.5					105	105	85	68	53.3		65	
70		91	94	82	68	54.8						97.5	83.5	67	53.3	41	70
75			88.5	80	67	54.3	42					82	66	53.2	41	75	
80			82	77.5	65.5	53.4	42	31.5				80.5	65	52.8	41	80	
85			74.5	74	64.5	52.4	42	31.5				78	64	52	41	85	
90			63.5	70	63	51.2	41.7	31.5	23.3			73.5	63	51.2	41	90	
95				66	61.5	50	41	31.5	22.8			66.5	62	50.3	40.9	95	
100				62	59.4	48.9	40.2	31.4	22.3				61	49.4	40.5	100	
105				57.5	56.3	47.7	39.2	31.1	21.8				60	48.4	39.7	105	
110				49.9	53.3	46.7	38.3	30.6	21.4				57.5	47.5	38.9	110	
115					50.6	45.7	37.5	30.2	20.9				52.8	46.7	38.1	115	
120					48.3	44.6	36.6	29.7	20.5					45.9	37.4	120	
125					45.9	43.5	35.8	29.1	20.1					45.1	36.7	125	
130					41.6	41.4	35.1	28.5	19.7					44.3	36	130	
135					36.9	39.5	34.3	27.8	19.3					42.5	35.4	135	
140						37.9	33.6	27.2	19						34.8	140	
145						36.3	32.9	26.6	18.6						34.3	145	
150						34.3	32.3	26	18.4						33.8	150	
155						30.6	31.2	25.6	18.1						33.4	155	
160							30.1	25.3	17.9						31.4	160	
165							29.1	25.2	17.7							165	
170							28	25	17.6							170	
175							25.6	24.8	17.5							175	
180								24.4	17.4							180	
185								23.6	17.1							185	
190								22.9	16.6							190	
195								21.4	16							195	
200								19.2	15.5							200	
205									15							205	
210									14.5							210	
215									14.1							215	
220									13.6							220	

* adapter / pièce d'adaptateur

Lifting capacities on the luffing lattice jib

Forces de levage à la fléchette treillis relevable



ft	83 ft + 13 ft*			117 ft + 13 ft*							151 ft + 13 ft*			ft		
	184 ft	207 ft	230 ft	57 ft	69 ft	92 ft	115 ft	138 ft	161 ft	184 ft	207 ft	230 ft	57 ft		69 ft	92 ft
40				91.5												40
45				91.5												45
50				91.5	78.5											50
55				90.5	78.5	61.5							55.2	47.2		55
60				88.5	78.5	61.5	48.2						55.2	47.2	35.7	60
65				85.5	78.5	61.5	48.2						55.2	47.2	35.7	65
70					77	61.5	48.2	37.5					55.2	47.2	35.7	70
75	31				75	61.5	48.2	37.5	28.3					47.2	35.7	75
80	31					60.5	48.2	37.5	28.3					47.2	35.7	80
85	31					60	48.2	37.5	28.3					47.2	35.7	85
90	31	24.1				59.4	47.7	37.5	28.3	22					35.7	90
95	31	24.1	17.6			59	47.2	37.5	28.3	22	16.1				35.7	95
100	31	24.1	17.6				46.7	37.5	28.3	22	16.1	11.3			35.7	100
105	31	24.1	17.6				46.3	37.5	28.3	22	16.1	11.3				105
110	31	24.1	17.6				45.8	37.2	28.3	22	16.1	11.3				110
115	30.8	24.1	17.6				45.4	36.7	28.3	22	16.1	11.3				115
120	30.4	24.1	17.6				45	36.3	28.3	22	16.1	11.3				120
125	29.8	24.1	17.4					35.8	28.3	22	16.1	11.3				125
130	29.2	23.7	17.1					35.3	28.2	22	16.1	11.3				130
135	28.6	23.3	16.8					34.9	27.9	22	16.1	11.3				135
140	28.1	22.8	16.6					34.6	27.5	21.9	16.1	11.3				140
145	27.5	22.4	16.3						27.1	21.8	16.1	11.3				145
150	27	22	16.1						26.7	21.4	16.1	11.3				150
155	26.6	21.7	15.8						26.4	21	16.1	11.3				155
160	26.3	21.4	15.7						26.2	20.8	16.1	11.3				160
165	26.2	21.1	15.6						26.2	20.6	16.1	11.3				165
170	26	20.9	15.5						26.2	20.4	16.1	11.3				170
175	25.8	20.7	15.4							20.4	16	11.3				175
180	25.6	20.6	15.3							20.4	15.9	11.3				180
185		20.5	15.3							20.4	15.8	11.3				185
190		20.4	15.2							20.4	15.8	11.3				190
195		20.4	15.2								15.8	11.3				195
200		20.4	15								15.8	11.3				200
205		19.6	14.7								15.8	11.3				205
210			14.2									11.3				210
215			13.8									11.3				215
220			13.5									11.3				220
225			13.2									11.3				225
230												11.3				230
235												11.3				235

* adapter / pièce d'adaptateur

TAB 122378

Lifting capacities on the luffing lattice jib

Forces de levage à la fléchette treillis relevable



ft	151 ft + 13 ft*						185 ft + 13 ft*						ft	
	115 ft	138 ft	161 ft	184 ft	207 ft	230 ft	57 ft	69 ft	92 ft	115 ft	138 ft	161 ft		184 ft
60							33.2	28.5						60
65							33.2	28.5						65
70	26.7						33.2	28.5	20.7					70
75	26.7	20					33	28.5	20.7	15				75
80	26.7	20	14.6					28.5	20.7	15				80
85	26.7	20	14.6					28.5	20.7	15				85
90	26.7	20	14.6					28.3	20.7	15	10.7			90
95	26.7	20	14.6	10.1					20.7	15	10.7	7.2		95
100	26.7	20	14.6	10.1	6.8				20.7	15	10.7	7.2	4.3	100
105	26.7	20	14.6	10.1	6.8	4			20.7	15	10.7	7.2	4.3	105
110	26.7	20	14.6	10.1	6.8	4			20.7	15	10.7	7.2	4.3	110
115	26.7	20	14.6	10.1	6.8	4				15	10.7	7.2	4.3	115
120	26.7	20	14.6	10.1	6.8	4				15	10.7	7.2	4.3	120
125	26.7	20	14.6	10.1	6.8	4				15	10.7	7.2	4.3	125
130	26.7	20	14.6	10.1	6.8	4				15	10.7	7.2	4.3	130
135		20	14.6	10.1	6.8	4					10.7	7.2	4.3	135
140		20	14.6	10.1	6.8	4					10.7	7.2	4.3	140
145		20	14.6	10.1	6.8	4					10.7	7.2	4.3	145
150		20	14.6	10.1	6.8	4					10.7	7.2	4.3	150
155			14.6	10.1	6.8	4					10.7	7.2	4.3	155
160			14.6	10.1	6.8	4						7.2	4.3	160
165			14.6	10.1	6.8	4						7.2	4.3	165
170			14.6	10.1	6.8	4						7.2	4.3	170
175				10.1	6.8	4						7.2	4.3	175
180				10.1	6.8	4							4.3	180
185				10.1	6.8	4							4.3	185
190				10.1	6.8	4							4.3	190
195				10.1	6.8	4							4.3	195
200					6.8	4								200
205					6.8	4								205
210					6.8	4								210
215					6.8	4								215
220						4								220
225						4								225
230						4								230
235						4								235

* adapter / pièce d'adaptateur

Lifting heights Hauteurs de levage

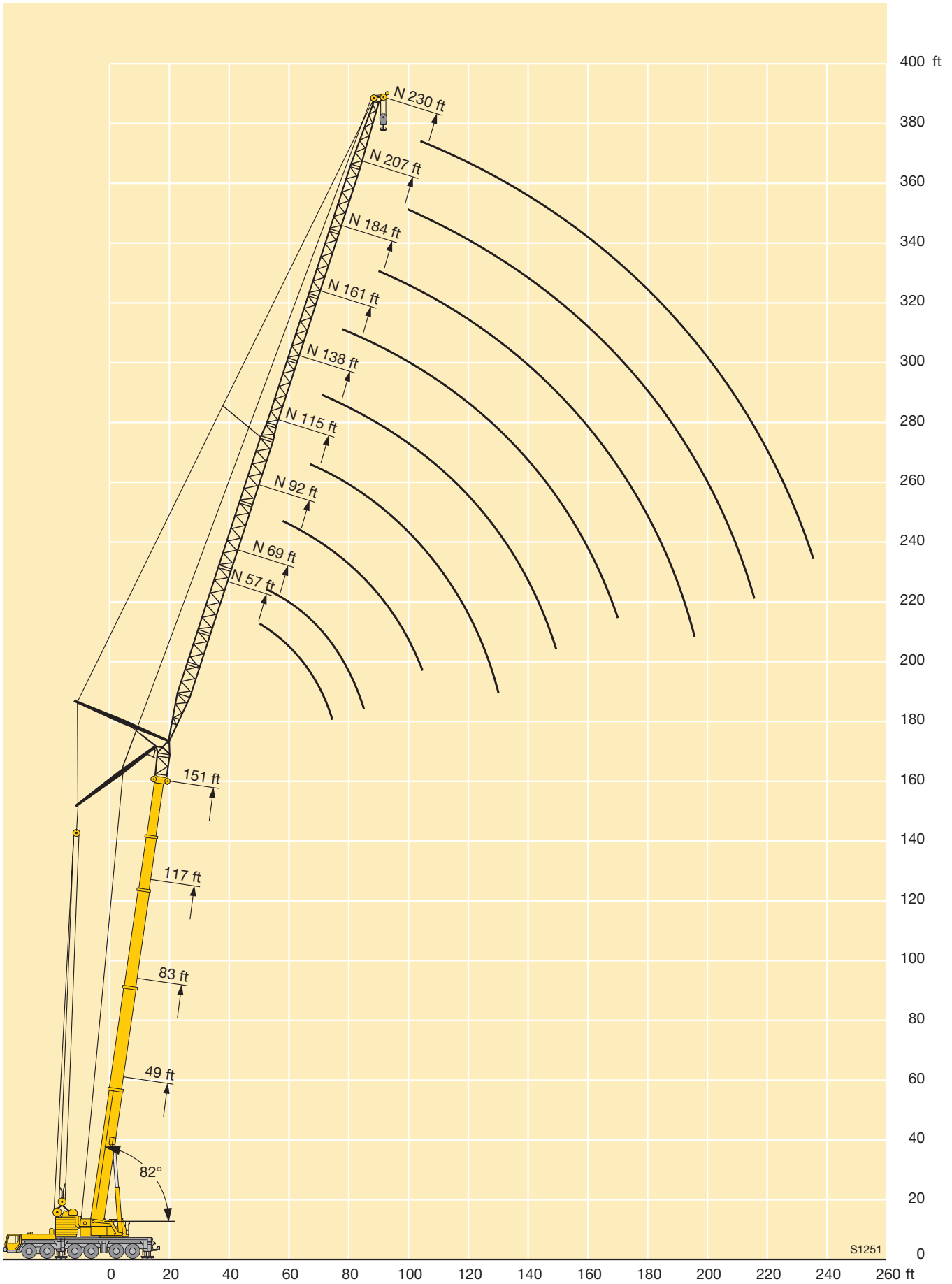

Lifting capacities on the luffing lattice jib

Forces de levage à la fléchette treillis relevable



ft	49 ft + 13 ft*									83 ft + 13 ft*						ft
	57 ft	69 ft	92 ft	115 ft	138 ft	161 ft	184 ft	207 ft	230 ft	57 ft	69 ft	92 ft	115 ft	138 ft	161 ft	
50	128															50
55	121	116														55
60	114	109	100													60
65	105	104	95.5									107	106			65
70		97	92									98.5	98			70
75		90.5	88	78.5								91.5	91			75
80			83.5	76	64.5							85	84.5	82		80
85			78.5	73.5	63								78.5	77.5		85
90			74	71	62								73.5	72.5		90
95			69.5	68	60.5	50.4							69	68	65.5	95
100			63.5	64.5	59.3	49.6	40.5						63.5	62.5	51.8	100
105				61	57.9	48.7	40.5						60	59	51.8	105
110				57.9	56.5	47.9	39.9						56.7	55.6	51.8	110
115				54.9	54.1	47.2	39.3	29.9					53.7	52.7	50.8	115
120				51.3	51.4	46.5	38.7	29.7					49.9	48.7	39.8	120
125					48.9	46	38.2	29.3	20.2				47.5	46.2	39.8	125
130					46.6	45.2	37.7	29	19.8				45.1	43.9	39.8	130
135					44.5	43.5	37.2	28.6	19.4				43	41.8	39.8	135
140					42.1	41.6	36.8	28.3	19.1					39.9	38.8	140
145					38.8	39.7	36.4	27.9	18.8					38.1	37.3	145
150					33.1	38.1	35.9	27.6	18.5					36.4	35.6	150
155						36.4	35.1	27.4	18.3					34.9	34.1	155
160						34.9	33.9	27.3	18.1					33.5	32.6	160
165						33.1	32.5	27.1	17.9						31.3	165
170						29	31.2	26.9	17.8						30	170
175							30	26.8	17.6						28.8	175
180								28.9	26.6	17.4					27.7	180
185								27.4	26.3	17.2						185
190								24.8	25.7	17						190
195								21.5	24.7	16.9						195
200									23.8	16.5						200
205									22.7	15.9						205
210									21.2	15.3						210
215									18.6	14.8						215
220										14.3						220
225										13.8						225
230										13.5						230
235										13.3						235

* adapter / pièce d'adaptateur

TAB 122379

Lifting capacities on the luffing lattice jib

Forces de levage à la fléchette treillis relevable



ft	83 ft + 13*			117 ft + 13*									151 ft + 13*			ft
	184 ft	207 ft	230 ft	57 ft	69 ft	92 ft	115 ft	138 ft	161 ft	184 ft	207 ft	230 ft	57 ft	69 ft	92 ft	
75				72	69.5											75
80				68.5	66.5											80
85				65.5	63.5											85
90					61	56.3							44.7			90
95					58.4	54.4	46.6						42.9	41.3		95
100						52.5	46.5							39.7	35.3	100
105						50.6	46.1	35.9							34.7	105
110						48.4	44.8	35.9							33.7	110
115	29.7					46.1	43.6	35.9							32.6	115
120	29.7						42.2	35.9	27.1						31.5	120
125	29.7	22.8					40.6	35.9	27.1	20.7					30.5	125
130	29.7	22.8					38.7	35.9	27.1	20.7					29.8	130
135	29.7	22.8	16.5				36.9	35.2	27.1	20.7						135
140	29.7	22.8	16.5				35.2	33.9	27.1	20.7	15					140
145	29.7	22.8	16.4					32.4	27.1	20.7	15	10.4				145
150	29.7	22.8	16.1					30.9	27.1	20.7	15	10.4				150
155	29.7	22.8	15.9					29.6	27.1	20.7	15	10.4				155
160	29.3	22.8	15.8					28.4	26.8	20.7	15	10.4				160
165	28.5	22.8	15.7						26	20.7	15	10.4				165
170	27.3	22.8	15.6						24.9	20.7	15	10.4				170
175	26.2	22.8	15.5						23.9	20.7	15	10.4				175
180	25.2	22.8	15.4						22.9	20.7	15	10.4				180
185	24.1	22.7	15.3						22	20.5	15	10.4				185
190	23.2	22.3	15.2						21.2	19.8	15	10.4				190
195	22.3	21.5	15.1							19	15	10.4				195
200	21.5	20.6	15							18.2	15	10.4				200
205		19.8	14.9							17.5	15	10.4				205
210		19	14.8								15	10.4				210
215		18.3	14.6								14.6	10.4				215
220		17.6	14.4								14.1	10.4				220
225			14.1								13.4	10.4				225
230			13.7								12.9	10.4				230
235			13.5								12.3	10.4				235
240			13.3									10.1				240
245			13									9.7				245
250												9.4				250
255												9.1				255

* adapter / pièce d'adaptateur

TAB 122379

Lifting capacities on the luffing lattice jib

Forces de levage à la fléchette treillis relevable



ft	151 ft + 13 ft*						185 ft + 13 ft*						ft	
	115 ft	138 ft	161 ft	184 ft	207 ft	230 ft	57 ft	69 ft	92 ft	115 ft	138 ft	161 ft		184 ft
100							26.2							100
105								23.2						105
110								22.3						110
115	26.7							21.5	18.6					115
120	26.7	19.9							17.9					120
125	26.7	19.9							17.4	14.3				125
130	26.4	19.9							16.8	13.9				130
135	25.8	19.9	14.4						16.2	13.4				135
140	25.1	19.9	14.4	9.8						13	10.4			140
145	24.4	19.9	14.4	9.8						12.5	10	7.2		145
150	23.7	19.9	14.4	9.8						12.1	9.7	7.2		150
155		19.9	14.4	9.8	6.5					11.7	9.3	7.2		155
160		19.8	14.4	9.8	6.5					11.3	9	7.1	4.3	160
165		19.6	14.4	9.8	6.5	3.8					8.7	7	4.3	165
170		19.1	14.4	9.8	6.5	3.8					8.5	6.8	4.3	170
175		18.8	14.4	9.8	6.5	3.8					8.2	6.6	4.3	175
180			14.4	9.8	6.5	3.8					8	6.4	4.3	180
185			14.4	9.8	6.5	3.8						6.2	4.3	185
190			14.4	9.8	6.5	3.8						6	4.3	190
195			14.4	9.8	6.5	3.8						5.8	4.1	195
200				9.8	6.5	3.8						5.7	4	200
205				9.8	6.5	3.8						5.5	3.8	205
210				9.8	6.5	3.8								210
215				9.8	6.5	3.8								215
220				9.8	6.5	3.8								220
225					6.5	3.8								225
230					6.5	3.8								230
235					6.5	3.8								235
240					6.5	3.8								240
245						3.8								245
250						3.8								250
255						3.8								255
260						3.8								260
265						3.8								265

* adapter / pièce d'adaptateur

TAB 122379

Lifting heights Hauteurs de levage

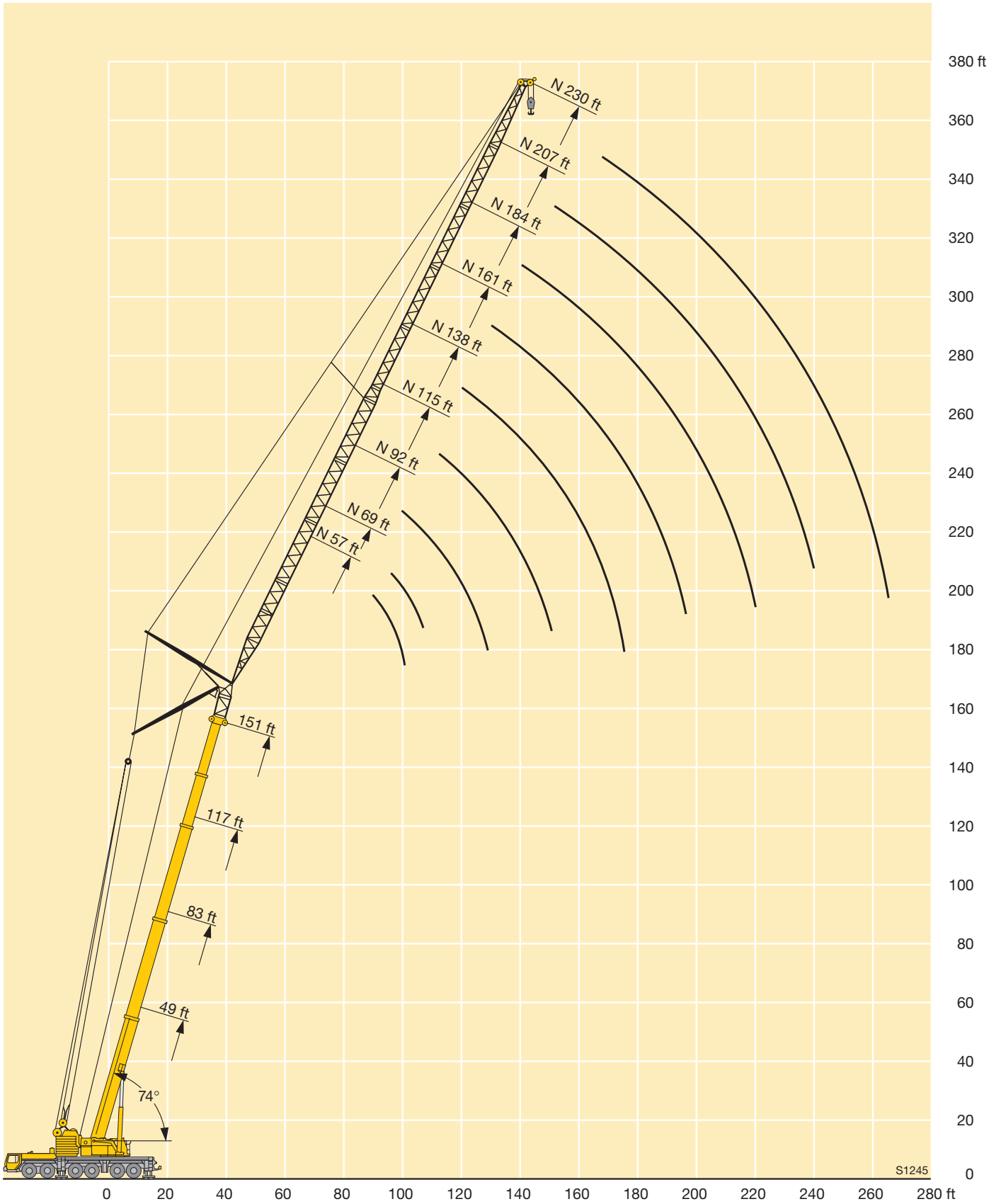

Lifting capacities on the luffing lattice jib

Forces de levage à la fléchette treillis relevable



ft	49 ft + 13 ft*								83 ft + 13 ft*						ft	
	57 ft	69 ft	92 ft	115 ft	138 ft	161 ft	184 ft	207 ft	230 ft	57 ft	69 ft	92 ft	115 ft	138 ft		161 ft
60	110															60
65	101															65
70	94	93.5														70
75	87.5	87														75
80		81.5	80.5							73.5						80
85		76.5	75.5							68.5						85
90			71							64.5	63.5					90
95			66.5	65.5							59.9					95
100			62.5	61.5								55.1				100
105			59.2	58.2	57.1							51.9				105
110			56.2	55.2	54.2							49.2				110
115				52.3	51.4							46.6	45.5			115
120				49.7	48.8	45.6						44.3	43.2			120
125				47.3	46.4	44.8							41.1	39.7		125
130				45.2	44.3	43.1							39.1	37.8		130
135					42.3	41.2	36.3						37.3	36		135
140					40.4	39.3	35.8						35.6	34.4	33.5	140
145					38.6	37.6	35.3	27.5						32.8	31.9	145
150					37	35.9	34.6	27.2						31.3	30.5	150
155					35.5	34.4	33.3	27.1						30	29.1	155
160						33	31.9	27	17.9					28.8	27.9	160
165						31.7	30.6	27	17.7					27.6	26.7	165
170						30.5	29.3	26.9	17.6					26.5	25.6	170
175						29.3	28.1	26.7	17.6						24.5	175
180							27	25.9	17.5						23.6	180
185							26	24.9	17.4						22.6	185
190							25	23.9	17.4						21.8	190
195							24.1	23	17.3							195
200							23.2	22.1	17.1							200
205								21.3	16.8							205
210								20.4	16.3							210
215								19.7	15.7							215
220								19	15.2							220
225									14.6							225
230									14.1							230
235									13.7							235
240									13.4							240
245									13.1							245

* adapter / pièce d'adaptateur

TAB 122380

Lifting capacities on the luffing lattice jib

Forces de levage à la flèche treillis relevable



ft	83 ft + 13 ft*			117 ft + 13 ft*							151 ft + 13 ft*							185 ft + 13 ft*				ft						
	184 ft	207 ft	230 ft	57 ft	69 ft	92 ft	115 ft	138 ft	161 ft	184 ft	207 ft	230 ft	57 ft	69 ft	92 ft	115 ft	138 ft	161 ft	184 ft	207 ft	230 ft		69 ft	92 ft	115 ft	138 ft		
95				53.1																							95	
100				50	49																							100
105					46.3																							105
110					43.8																							110
115					41.5	40.1							31.8															115
120						38								29.6														120
125						36	34.9							28.3														125
130						34.3	33.1							27.2														130
135						32.7	31.5								24.1													135
140							30	28.6							23.2								15					140
145							28.7	27.2							22.4	20.5												145
150							27.4	26							21.6	19.7												150
155	27.5						26.2	24.8	23.4							18.9							11					155
160	26.3						25.1	23.6	22.3							18.2	16.6						10.5					160
165	25.1	22							22.6	21.2	19.7					17.5	15.9							8.2				165
170	24	22							21.6	20.2	18.8					16.9	15.2							7.8				170
175	23	21.8							20.7	19.3	17.9					16.6	14.6	12.9						7.5				175
180	22	21.1	15.2						19.8	18.4	17	14.6					14.1	12.3						7.2	5.9			180
185	21	20.1	15.2							17.6	16.2	14.5					13.6	11.8	9.6					7	5.6			185
190	20.2	19.3	15.1							16.8	15.4	13.8					13.1	11.2	9.3					6.7	5.4			190
195	19.3	18.4	15.1							16.1	14.6	13	10.4				12.8	10.8	8.9						5.2			195
200	18.5	17.6	15.1							15.4	13.9	12.2	10.2					10.3	8.5	6.5					4.9			200
205	17.8	16.8	15							14.8	13.2	11.5	9.8					9.9	8.1	6.5					4.7			205
210	17.1	16.1	14.7								12.5	10.8	9.4					9.5	7.8	6.5								210
215	16.5	15.4	14								11.9	10.2	8.9					9.3	7.5	6.3								215
220		14.8	13.3								11.3	9.7	8.5					9.1	7.3	6	3.8							220
225		14.1	12.7								10.7	9.4	8.2						7	5.8	3.8							225
230		13.5	12.1									9	7.8						6.8	5.5	3.8							230
235		13	11.5									8.7	7.5						6.6	5.3	3.8							235
240			10.9									8.4	7.2						6.6	5.1	3.8							240
245			10.4									8.1	6.9							4.9	3.6							245
250			9.9									7.8	6.6							4.7	3.5							250
255			9.6									7.5	6.3							4.6	3.3							255
260			9.3										6							4.5	3.1							260
265													5.8							4.3	2.9							265
270													5.6								2.8							270
275													5.4								2.7							275
280																					2.5							280

* adapter / pièce d'adaptateur

TAB 122380

Lifting heights Hauteurs de levage

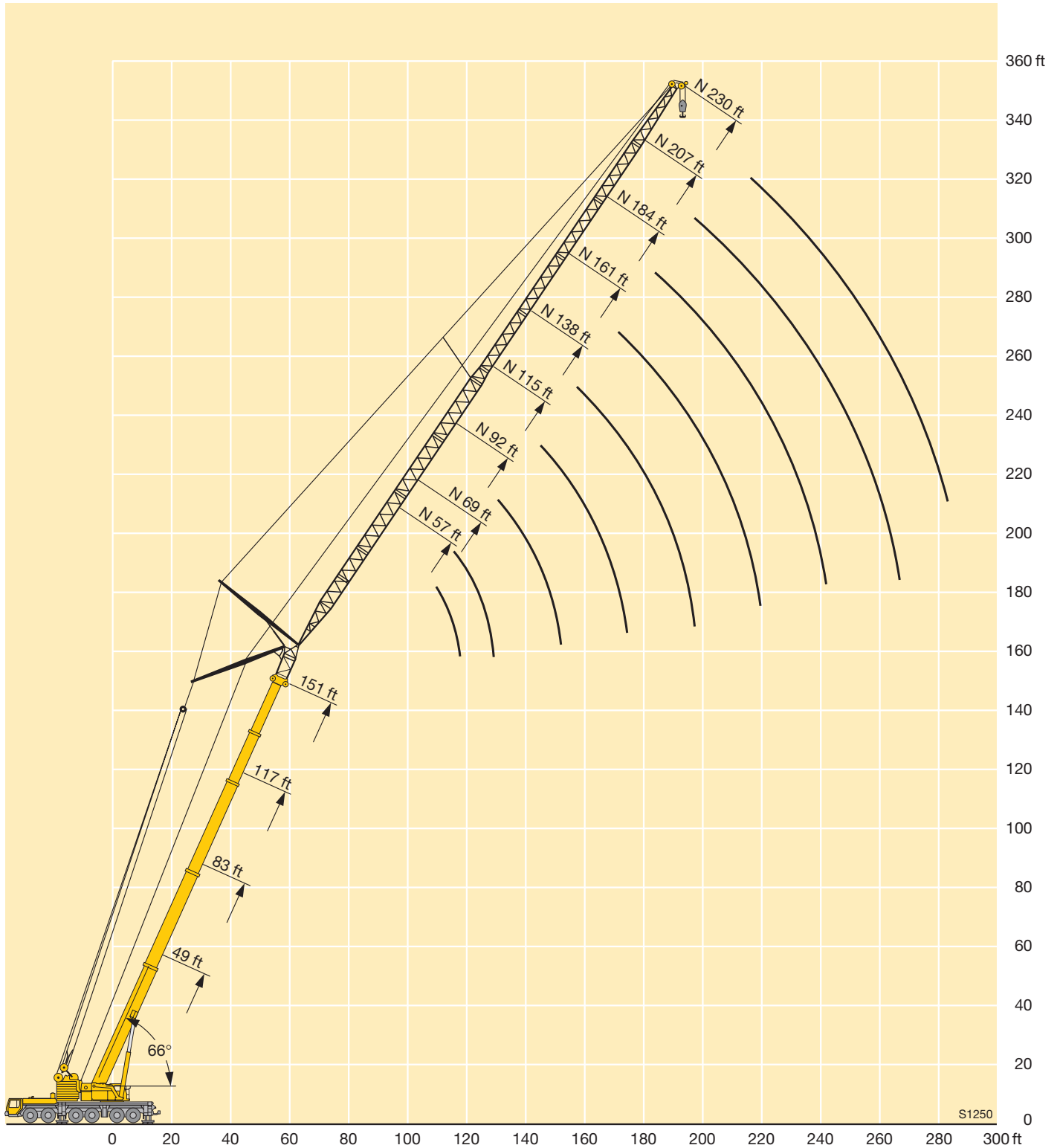

Lifting capacities on the luffing lattice fly jib with guyed telescopic boom

Forces de levage à la fléchette treillis relevable avec flèche télescopique haubanée



ft	117 ft + 13 ft*								151 ft + 13 ft*			ft
	69 ft	92 ft	115 ft	138 ft	161 ft	184 ft	207 ft	230 ft	69 ft	92 ft	115 ft	
100	57.1											100
105	54											105
110	51.3											110
115	48.8	47.1							39.2			115
120		44.8							39.2			120
125		42.6	41.5						39.1	30.8		125
130		40.7	39.5						37.7	30.7		130
135		38.9	37.7							30.6		135
140			36.1	34						30.6	24.1	140
145			34.5	33.1						30.5	24	145
150			33.1	31.7						29.9	23.9	150
155			31.7	30.3	25.8						23.9	155
160			30.5	29.1	25.8						23.9	160
165				27.9	25.8	19.8					23.9	165
170				26.8	25.4	19.8					23.9	170
175				25.8	24.5	19.8					23.3	175
180				24.8	23.5	19.8	14.6					180
185					22.6	19.8	14.6					185
190					21.7	19.8	14.6					190
195					20.9	19.3	14.6	10.2				195
200					20.1	18.7	14.6	10.2				200
205					19.3	17.9	14.6	10.2				205
210						17.2	14.6	10.2				210
215						16.5	14.6	10.2				215
220						15.8	14.3	10.2				220
225						15.2	13.7	10.2				225
230							13.1	10.2				230
235							12.5	10.2				235
240							12	10				240
245							11.4	9.8				245
250							10.9	9.4				250
255							10.5	9.1				255
260								8.8				260
265								8.5				265
270								8.2				270
275								8				275

* adapter / pièce d'adaptateur

TAB 122383

Lifting capacities on the luffing lattice fly jib with guyed telescopic boom

Forces de levage à la fléchette treillis relevable avec flèche télescopique haubanée

ft	151 ft + 13 ft*					185 ft + 13 ft*				ft		
	138 ft	161 ft	184 ft	207 ft	230 ft	69 ft	92 ft	115 ft	138 ft		161 ft	184 ft
135						21.2						135
140						21.1						140
145							16.3					145
150							16.2					150
155	18.5						16.1					155
160	18.5						16	11.9				160
165	18.5							11.9				165
170	18.5							11.9				170
175	18.5	13.7						11.9	8.5			175
180	18.5	13.7						11.9	8.5			180
185	18.5	13.7	9.4					11.9	8.5			185
190	18.5	13.7	9.4					11.9	8.5			190
195	18.3	13.7	9.4						8.5	6.1		195
200		13.7	9.4	6.2					8.5	6.1		200
205		13.7	9.4	6.2					8.5	6.1	3.7	205
210		13.7	9.4	6.2	3.5					6.1	3.7	210
215		13.7	9.4	6.2	3.5					6.1	3.7	215
220		13.6	9.4	6.2	3.5					6.1	3.7	220
225			9.4	6.2	3.5					6.1	3.7	225
230			9.4	6.2	3.5					6.1	3.7	230
235			9.4	6.2	3.5					6.1	3.7	235
240			9.4	6.2	3.5						3.7	240
245				6.2	3.5						3.7	245
250				6.2	3.5						3.7	250
255				6.2	3.5						3.7	255
260				6.2	3.5							260
265				6.2	3.5							265
270					3.5							270
275					3.5							275
280					3.5							280
285					3.5							285

* adapter / pièce d'adaptateur

TAB 122383

Lifting heights Hauteurs de levage

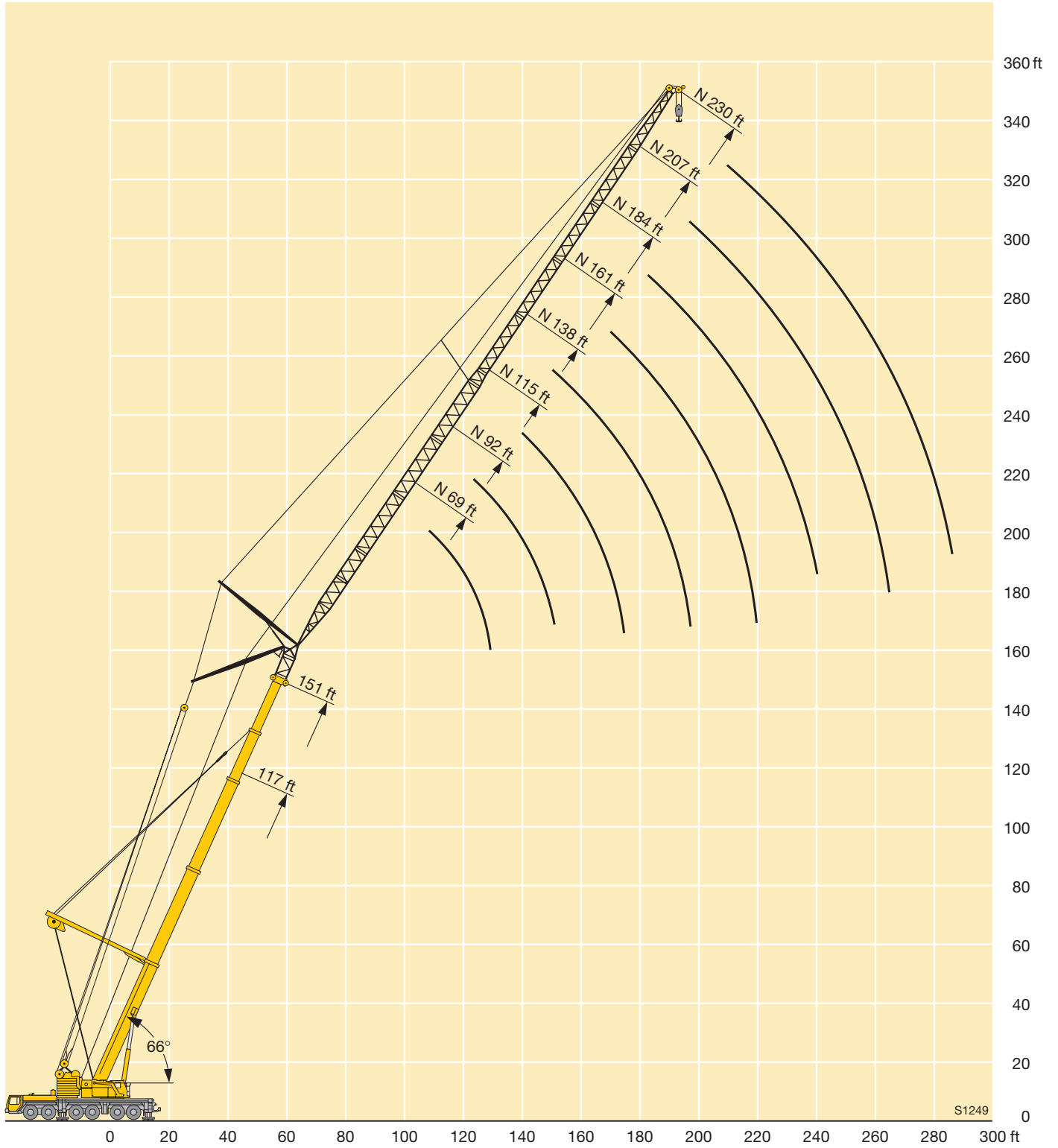

Dimensions Encombrement

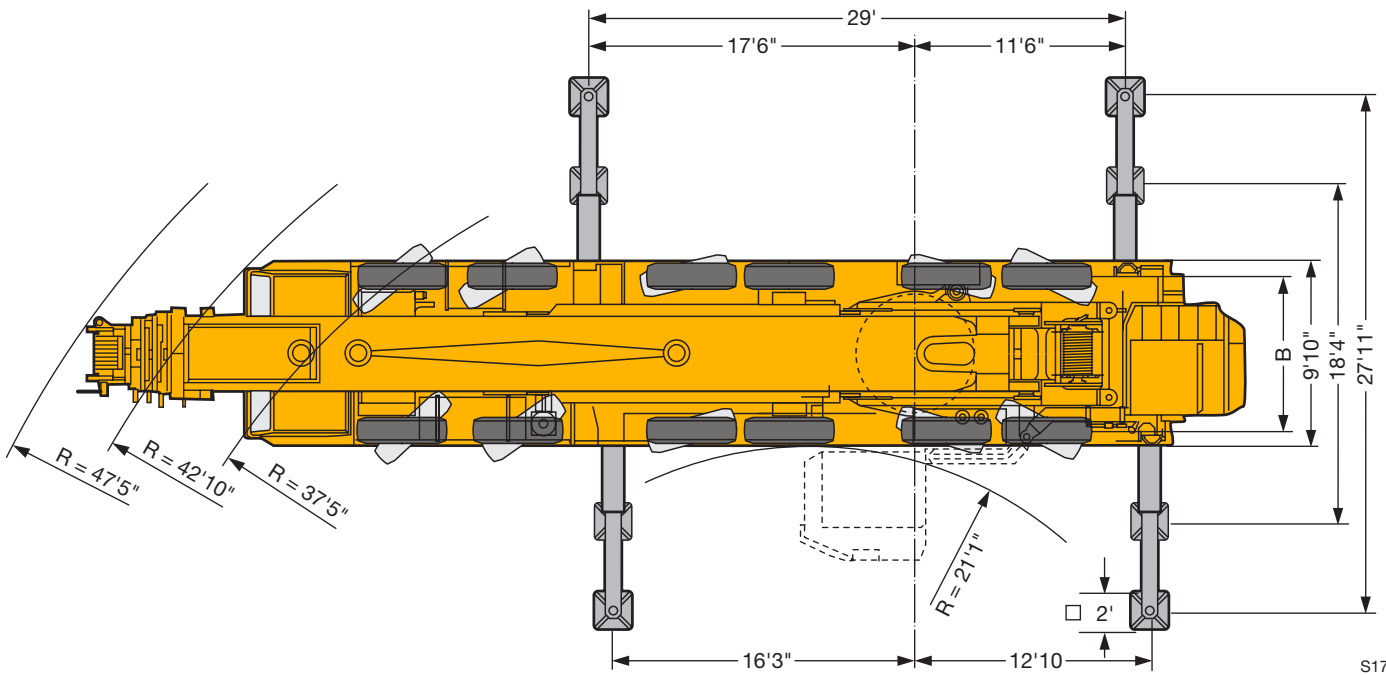
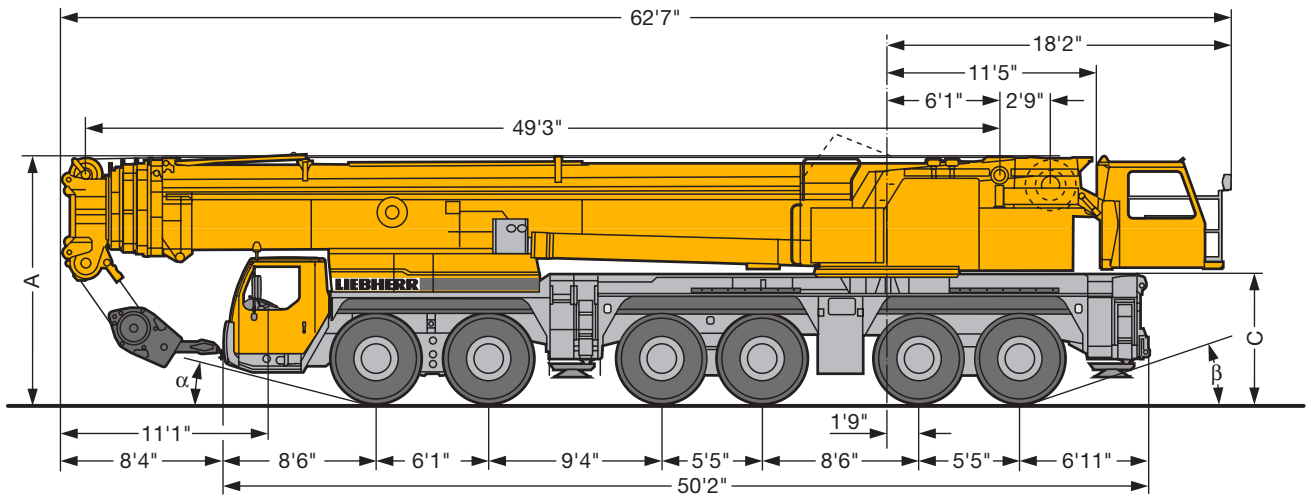

	Dimensions / Encombrement mm					
	A	A*	B	C	α	β
16.00 R 25 * lowered / abaissé	13' 1 1/2"	12' 7 1/2"	8' 4 1/2"	6' 9"	17°	19°

Weights Poids







Axle Essieu lbs	1	2	3	4	5	6	Total weight (metric tons) Poids total t
	26500	26500	26500	26500	26500	26500	159000









Load (kips) Forces de levage kips	No. of sheaves Poulies	No. of lines Brins	Weight lbs Poids lbs
473	12	24	5280
387	9	18	3960
314	7	14	3740
238	5	10	3190
156	3	6	2200
70	1	3	1850
23	-	1	1100

Working speeds Vitesses



	1	2	3	4	5	R	
 mph	9.3	15	23	34	47	8.7	-
 mph	5	8.7	13.7	20	27.5	4.7	39 %
	16.00 R 25						



Drive Mécanismes	infinitely variable en continu	Rope diameter / Rope length Diam. du câble / Longueur du câble	Max. single line pull Effort au brin maxi.
	0 - 460 m/min single line m/min au brin simple	1 ¹ / ₂ " / 1476'	23600 lbs
	0 - 460 m/min single line m/min au brin simple	1 ¹ / ₂ " / 1476'	23600 lbs
	0 - 460 m/min single line m/min au brin simple	1 ¹ / ₂ " / 2100'	23600 lbs
	0 - 1.5 rpm		
	approx. 70 seconds to reach 82° boom angle env. 70 s jusqu'à 82°		
	approx. 500 seconds for boom extension from 49 ft – 197 ft env. 500 s pour passer de 49 ft – 197 ft		

Equipment Equipment

Crane carrier

Frame	Liebherr designed and manufactured, box-type, torsion resistant design of high-tensile fine grained structural steel.
Outriggers	Four hydraulically extendable sliding beams with hydraulic jacks and supporting pads. The front outrigger casing is mounted between axles 2 and 3 and the rear casing is located at the rear of the carrier. Supporting basis: 20' longitudinally x 27'11" transversally.
Engine	8-cylinder Diesel engine, make Liebherr, type D 9408 TI-E, watercooled, output acc. to DIN 440 kW (598 HP) at 1900 rpm acc. to ECE-R 24.03 and 2001/27/EG (Euro 3), max. torque 1915 lbs/ft at 1400 rpm. Fuel tank: 158 gallons.
Transmission	Automatic transmission system with converter control clutch, make ZF, type TC-TRONIC with 12 forward speeds and 2 reverse speeds, transfer case with transfer differential.
Axles	Heavy-duty vehicle axles. All axles suspended. Axles 1 to 3 and 5 and 6 steered. Axles 1, 5 and 6 are planetary axles, intermediate differential at axle 5, all driven axles with transverse differential.
Cardan shaft	All cardan shafts with 70° diagonal toothing.
Suspension	All axles with hydropneumatic suspension and automatic levelling system. Load equalization between the axle pairs 1 + 2, 3 + 4 and 5 + 6. The suspension can be locked hydraulically.
Tyre equipment	12 tyres, all axles equipped with single tyres. Size of tyres: 16.00 R 25.
Steering	ZF semi-integral power steering, dual circuit system with hydraulic servo-system and additional backing pump driven by an axle.
Brakes	Service brake: All-wheel servo-air brake, dual circuit system. Additional brakes: Retarder, TELMA-type eddy current brake (optional). Hand brake: Spring-loaded, acting on all wheels of axles 2 to 6.
Driving cab	Spacious sheet steel cab mounted on rubber shock absorbers, safety glass windows, operating and control elements.
Electrical system	Modern data bus technique, 24 Volt DC, 2 batteries of 170 Ah each, lighting according to traffic regulations.

Crane superstructure

Frame	Liebherr-made torsion resistant, welded construction of high-tensile structural steel, linked to carrier by a three-row roller slewing rim for 360° continuous rotation.
--------------	--

Crane engine	4-cylinder Diesel engine, make Liebherr, type D 924 TI-E, watercooled, output acc. to DIN 180 kW (245 HP) at 1800 rpm, max. torque lbd/ft at 1100 rpm. Fuel tank capacity: 79 gallons.
Crane drive	Diesel-hydraulic, with 3 axial piston variable displacement pumps, with servo-control and capacity control.
Crane control	Two self-centering control levers (joy-sticks). Pedal switches for telescoping. Infinitely variable crane motions through displacement control of the hydraulic pumps. Additional working speed control by variation of the Diesel engine speed.
Hoist gear	Axial piston variable displacement motor, Liebherr hoist drum with integrated planetary gear and spring-loaded static brake.
Luffing gear	2 differential hydraulic rams with nonreturn valve.
Slewing gear	Hydraulic motor, planetary gear, slewing pinion and spring-loaded static brake.
Crane cab	Aluminium design with safety glass, operating and control elements. Cab tiltable backwards. The cab will be pivoted to the rear for road transport.
Safety devices	LICCON safe load indicator, test system, hoist limit switches, safety valves against rupture of pipes and hoses.
Counterweight	192500 lbs counterweight comprising 1 basic slab of 27500 lbs and 6 slabs of 27500 lbs each.
Telescopic boom	1 base section and 4 telescopic sections. All telescopic sections extendable individually by means of the rapid-cycle telescoping system TELEMATIK. Boom length 49 ft to 197 ft.
Electric system	Modern data bus technique, 24 Volt DC, 2 batteries of 170 Ah each.

Complementary equipment

Guying system for telescopic boom	Consisting of guying frame with rope winch, tiltable in transport condition.
Additional ballast	2 additional counterweight slabs of 27500 lbs each for a total counterweight of 247500 lbs, required for the operation with guyed telescopic boom.
Folding jibs	Single folding jib, 40 ft long, for mounting on telescopic boom at 0°, 20° or 40°. Double folding jib, 40 ft to 69 ft long, for mounting on telescopic boom at 0°, 20° or 40°.
Lattice jibs	Fixed lattice jib 46 ft to 161 ft long, luffing lattice jib 57 ft to 230 ft long.
2nd hoist gear	For 2-hook operation or luffing of lattice jib.
Drive 12 x 8	Axle 2 additionally driven.

Other items of equipment available on request.

Equipment Équipement

Châssis porteur

Châssis	Fabrication Liebherr, construction en caisson indéformable, en acier à haute résistance à grains fins.
Stabilisateurs	Quatre poutres horizontales télescopiques, avec vérins hydrauliques de calage verticaux et patins. Les caissons de poutres de calage avants sont situés entre les essieux 2 et 3, et les caissons des poutres de calage arrière sont situés à l'arrière du châssis. Surface de calage: 29' en long et 27'11" travers.
Moteur	Diesel 8 cylindres, marque Liebherr, type D 9408 TI-E, refroidi par eau, puissance selon DIN 440 kw (598 ch) à 1900 rpm selon ECE-R 24.03 et 2001/27/EG (Euro 3), couple max. 1915 lbs/ft à 1400 rpm. Réservoir à carburant : 158 gallons.
Boîte de vitesse	Boîte automatique avec convertisseur-embayage, marque ZF, type TC-TRONIC avec 12 marches AV et 2 marches AR, boîte de transfert avec différentiel répartiteur.
Essieux	Essieux spéciaux pour grue. Les 6 essieux sont suspendus. Les essieux 1 à 3, 5 et 6 sont directeurs. Les essieux 1, 5 et 6 sont des essieux planétaires, entraînés, différentiel intermédiaire à l'essieu 5, tous les essieux moteurs avec différentiel transversal.
Arbres articulés	Tous les arbres articulés à denture étagée de 70°.
Suspension	Tous les essieux sont suspendus hydropneumatiquement avec mise à niveau et équilibrage entre essieux automatiques. Egalisation de la charge par essieu entre essieux 1 + 2, 3 + 4 et 5 + 6. Suspension blocable hydrauliquement.
Pneumatiques	12 roues à monte simple. Taille: 16.00 R 25.
Direction	Direction semi-bloc ZF, à double circuit, assistée hydrauliquement, avec pompe auxiliaire entraînée par un essieu.
Freins	Frein de service: à double circuit assisté pneumatiquement, sur toutes les roues. Frein auxiliaire: par clapets sur échappement commandés avec le ralentisseur hydraulique, ralentisseur électrodynamique Telma (en option). Frein de secours et frein à main: par cylindres à ressorts sur les essieux 2 à 6.
Cabine	Cabine spacieuse, en tôle d'acier, suspendue sur silent blocs, vitrage de sécurité, tableau de bord complet.
Installation électrique	Technique moderne de transmission de données par BUS de données, courant continu 24 Volts, 2 batteries de 170 Ah chacune, éclairage conforme au code de la route.

Partie tournante

Châssis	Construction mécanosoudée en tôle d'acier à haute résistance à grains fins. Reliée au porteur par une couronne d'orientation à 3 rangées de rouleaux. Rotation totale 360°.
----------------	---

Moteur	Diesel 4 cylindres, marque Liebherr, type D 924 TI-E, refroidi par eau, puissance DIN 180 kw (245 ch) à 1800 rpm, couple max. 770 lbs/ft à 1100 rpm. Réservoir à carburant: 79 gallons.
Entraînement	Diesel hydraulique à 3 pompes à débit variable servo commandées à régulation de puissance.
Commande	2 leviers à 4 directions avec rappel automatique au point mort. Commande des mouvements progressive en continu par variation de l'inclinaison des pompes et augmentation du régime moteur.
Treuil	Moteur hydraulique à cylindrée variable, treuil de marque Liebherr avec réducteur planétaire à frein d'arrêt à lamelles intégrées.
Relevage de flèche	2 vérins hydrauliques différentiels avec clapets anti-retour de sécurité.
Orientation	Un moteur hydraulique, un réducteur planétaire, un pignon d'orientation et un frein à lamelles.
Cabine de grue	Cabine spacieuse, en tôle d'acier, avec vitrage de sécurité, tous les instruments de commande et de contrôle. Cabine inclinable, tournée sur l'arrière de la grue en position route.
Sécurités	Contrôleur de charge LICCON, système test, fin de course crochet haut, clapets de sécurité en cas de ruptures de flexibles.
Contrepoids	192500 lbs, composé d'une plaque de base de 27500 lbs et 6 plaques de 27500 lbs unitaires.
Flèche télescopique	Un élément de base et de 4 télescopes. Chaque partie peut être télescopée individuellement à l'aide du système de télescopage séquentiel rapide TELEMATIK. Longueur de flèche: 49 ft – 197 ft.
Circuit électrique	Technique moderne de transmission de données par BUS de données. Courant continu 24 Volts, 2 batteries de 170 Ah chacune.

Équipement optionnel

Haubanage de flèche	Composé du chevalet et du treuil.
Contrepoids complémentaire	2 plaques complémentaires de 27500 lbs, pour une masse totale de 247500 lbs, pour travail en télescope haubané.
Fléchettes pliante	Fléchette pliante, 40 ft, pour le montage à la flèche télescopique à 0°, 20° ou 40°. Fléchette pliante double, 40 ft m à 69 ft, pour montage à la flèche télescopique à 0°, 20° ou 40°.
Fléchettes	Fléchette fixe de 46 ft à 161 ft; fléchette à volée variable de 57 ft à 230 ft.
Deuxième treuil	Pour le travail avec 2 crochets ou le relevage de la fléchette treillis.
Entraînement 12 x 8	2ème essieu est entraîné additionnellement.

Autres équipement supplémentaires sur demande.

Liebherr-Werk Ehingen GmbH

Postfach 1361, 89582 Ehingen, Germany

☎ +49 73 91 5 02-0, Fax +49 73 91 5 02-33 99

www.liebherr.com, E-mail: info.lwe@liebherr.com